

ФИТИНГИ РЕЗЬБОВЫЕ И ПРИВАРНЫЕ КАТАЛОГ



Архангельск (8182)63-90-72
Астана +7(7172)727-132
Астрахань (8512)99-46-04
Барнаул (3852)73-04-60
Белгород (4722)40-23-64
Брянск (4832)59-03-52
Владивосток (423)249-28-31
Волгоград (844)278-03-48
Вологда (8172)26-41-59
Воронеж (473)204-51-73
Екатеринбург (343)384-55-89
Иваново (4932)77-34-06
Ижевск (3412)26-03-58
Казань (843)206-01-48

Калининград (4012)72-03-81
Калуга (4842)92-23-67
Кемерово (3842)65-04-62
Киров (8332)68-02-04
Краснодар (861)203-40-90
Красноярск (391)204-63-61
Курск (4712)77-13-04
Липецк (4742)52-20-81
Магнитогорск (3519)55-03-13
Москва (495)268-04-70
Мурманск (8152)59-64-93
Набережные Челны (8552)20-53-41
Нижний Новгород (831)429-08-12
Новокузнецк (3843)20-46-81

Новосибирск (383)227-86-73
Омск (3812)21-46-40
Орел (4862)44-53-42
Оренбург (3532)37-68-04
Пенза (8412)22-31-16
Пермь (342)205-81-47
Ростов-на-Дону (863)308-18-15
Рязань (4912)46-61-64
Самара (846)206-03-16
Санкт-Петербург (812)309-46-40
Саратов (845)249-38-78
Севастополь (8692)22-31-93
Симферополь (3652)67-13-56
Смоленск (4812)29-41-54

Сочи (862)225-72-31
Ставрополь (8652)20-65-13
Сургут (3462)77-98-35
Тверь (4822)63-31-35
Томск (3822)98-41-53
Тула (4872)74-02-29
Тюмень (3452)66-21-18
Ульяновск (8422)24-23-59
Уфа (347)22948 -12
Хабаровск (4212)92-98-04
Челябинск (351)202-03-61
Череповец (8202)49-02-64
Ярославль (4852)69-52-93

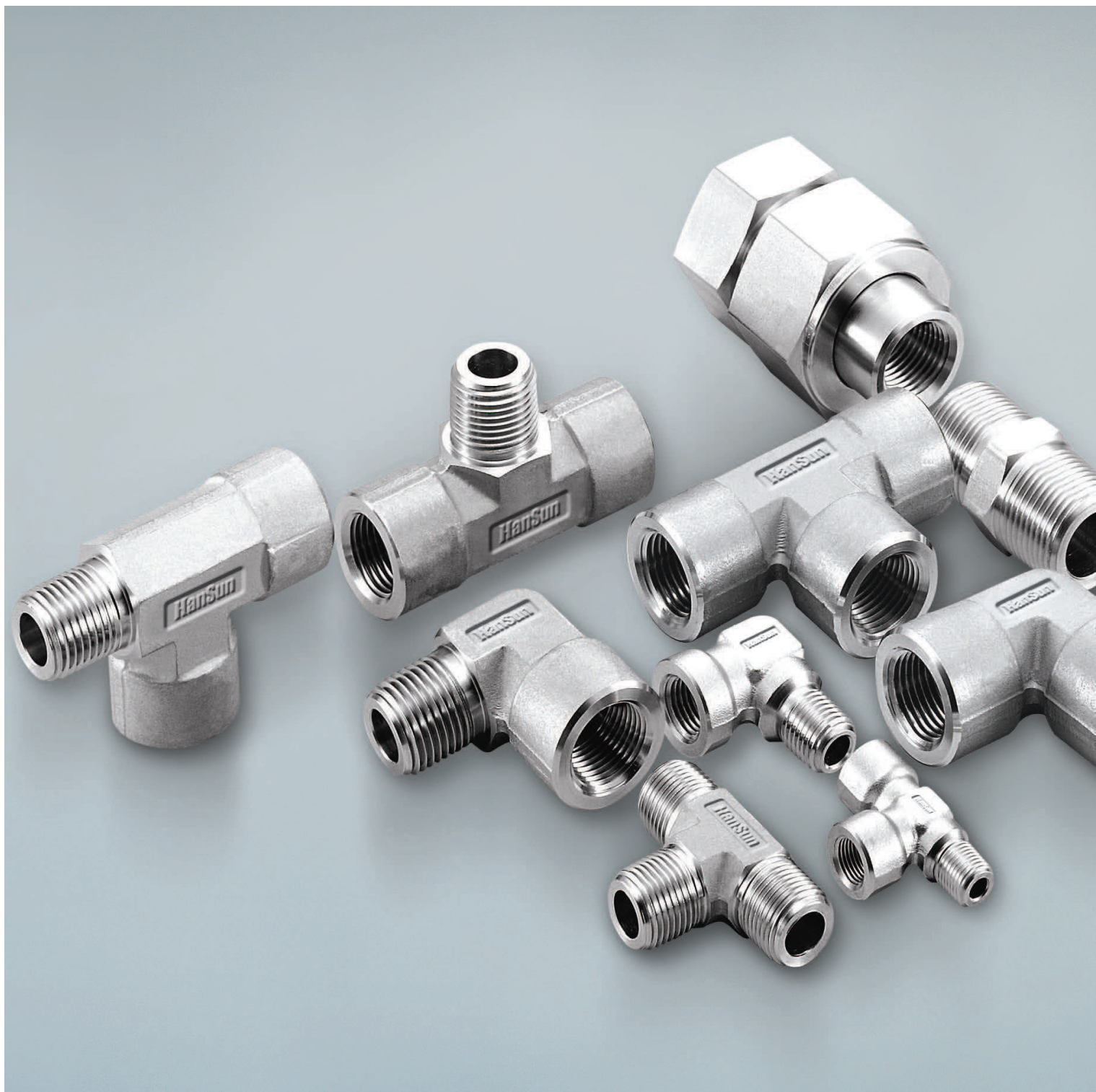

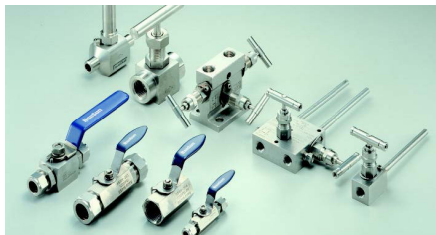
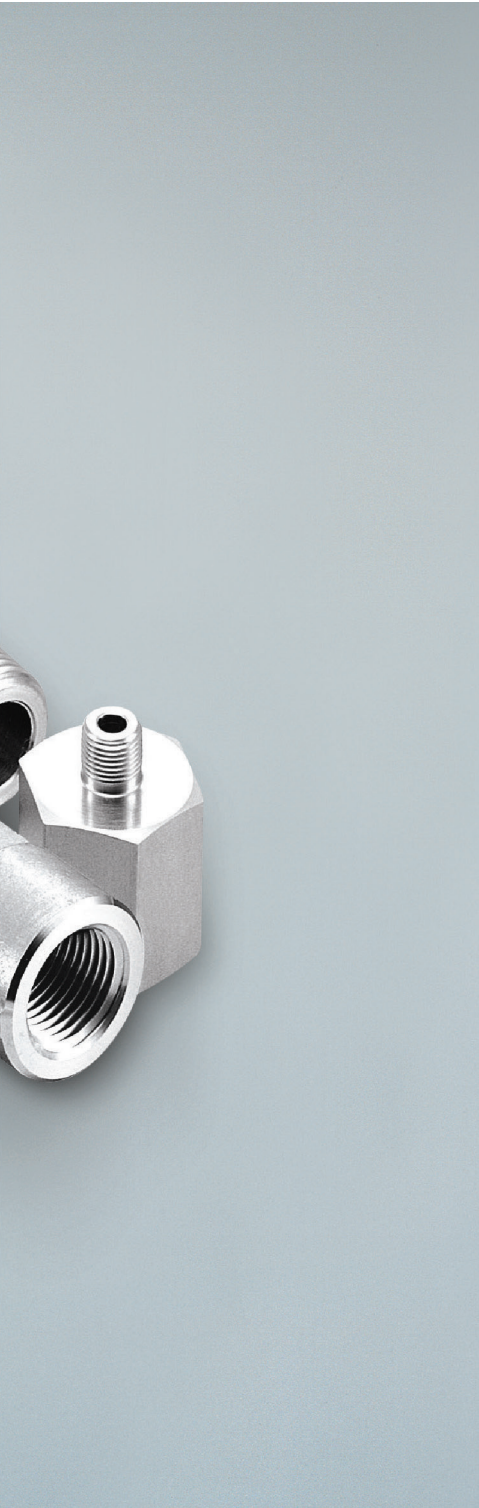

Характеристики

- Резьбовые и приварные фитинги разработаны согласно ASME B31.3 для приборов и технологического процесса
- Все наружные резьбы оснащены защитными колпачками
- Все внутренние и наружные резьбы не имеют заусенцев
- Резьбы NPT отвечают требованиям ASME B1.20.1

Стандарты на материалы и температура

Материал	Профиль	Поковка	Температура
SS316	ASTM A479 ASTM A276	ASTM A182	-325°F ... 1200°F (-198°C ... 648°C)
Латунь	ASTM B16, ASTM B453	ASTM B283	-325°F ... 400°F (-198°C ... 204°C)
Углеродистая сталь	ASTM A108 JIS G4051	JIS G4051	-20°F ... 350°F (-29°C ... 176°C)

Давление

Обозначение	Резьба NPT	Нержавеющая сталь 316				Латунь				Углеродистая сталь			
		Наружная		Внутренняя		Наружная		Внутренняя		Наружная		Внутренняя	
		psig	бар	psig	бар	psig	бар	psig	бар	psig	бар	psig	бар
1	1/16	11,000	758	6,700	462	5,500	379	3,300	227	11,000	758	6,700	462
2	1/8	10,000	689	6,500	448	5,000	345	3,200	221	10,000	689	6,500	448
4	1/4	8,000	551	6,600	455	4,000	276	3,300	227	8,000	551	6,600	455
6	3/8	7,800	538	5,300	365	3,900	269	2,600	179	7,800	538	5,300	365
8	1/2	7,700	531	4,900	338	3,800	262	2,400	165	7,700	531	4,900	338
12	3/4	7,300	503	4,600	317	3,600	248	2,300	159	7,300	503	4,600	317
16	1	5,300	365	4,400	303	2,600	179	2,200	152	5,300	365	4,400	303
20	1 1/4	6,000	414	5,000	345	3,000	207	2,500	172	6,000	414	5,000	345
24	1 1/2	5,000	345	4,600	317	2,500	172	2,300	159	5,000	344	4,600	317
32	1	3,900	269	3,900	269	1,900	131	1,900	131	3,900	269	3,900	269

- Давления в таблице приводятся при температуре до 37°C (100°F).
- Давления рассчитаны согласно ASME B31.3 при значении допустимого напряжения: 20 000psi для нерж. 316; 10 000psi для латуни; 20 000psi для углеродистой стали.
- Для определения рабочих давлений в соответствии ASME B31.1 умножьте давление на 0.94. Для латуни значения останутся такими же.
- Давления для внутренней резьбы ниже чем для наружной, т.к. наружный диаметр внутренней резьбы больше.
- Для перевода в kPa умножьте psig на 6,89.
- Давления для футорки (P-SHB) не приводятся в этой таблице. Смотрите значения давлений в таблице размеров.

Информация для заказа

Обозначение типа и размера резьбы

Материал	SS316	SS316L	Углер. сталь	Латунь
Обозначение	S6	S6L	CS	BS



Размер	Обозначение	NPT	Резьба ISO	
			Коническая (7/1)	Цилиндрич. (228/1)
1/8	2	2N	2R	2G
1/4	4	4N	4R	4G
3/8	6	6N	6R	6G
1/2	8	8N	8R	8G
3/4	12	12N	12R	12G
1	16	16N	16R	16G

P-SCN		
Ниппель NPT		
	06	
P-SHN		
Ниппель шестигранный NPT		
	06	
P-SHRN		
Ниппель переходной NPT		
	06	
P-SHN		
Ниппель шестигранный NPT / ISO (R)		
	07	
P-SHN		
Ниппель шестигранный NPT / ISO (G)		
	07	
P-SHLN		
Ниппель шестигранный удлиненный NPT		
	07	
P-MFAA		
Адаптер NPT		
	07	
P-MFRA		
Адаптер переходной NPT		
	08	
P-MFAA		
Адаптер переходной NPT / ISO (R)		
	08	
P-MFAB		
Адаптер переходной NPT / ISO (G)		
	08	
P-SHB		
Футорка NPT		
	08	

P-SC		
Заглушка NPT		
	09	
P-SP		
Пробка NPT		
	09	
P-SHC		
Муфта NPT		
	09	
P-SHRC		
Муфта переходная NPT		
	09	
P-SL		
Угольник NPT		
	10	
P-SSL		
Угольник NPT		
	10	
P-SRSL		
Угольник переходной NPT		
	10	
P-SML		
Угольник NPT		
	10	
P-ST		
Тройник NPT		
	11	
P-SRT		
Тройник NPT		
	11	
P-SBT		
Тройник NPT		
	11	

P-SMT		
Тройник NPT		
	11	
P-SUJ		
Муфта разборная NPT		
	11	
P-SWFC		
Муфта под приварку		
	13	
P-SWLA		
Угольник под приварку		
	13	
P-SWTA		
Тройник под приварку		
	13	
P-SSA		
Штуцер под приварку с резьбой NPT		
	13	
P-SSB		
Штуцер под приварку с резьбой NPT		
	13	
P-SMLSW		
Угольник под приварку с резьбой NPT		
	13	
P-SFLSW		
Угольник под приварку с резьбой NPT		
	14	
P-SWRM		
Муфта под приварку		
	14	
P-SWRM		
Муфта под приварку		
	14	

P-SCN

Ниппель с резьбой NPT

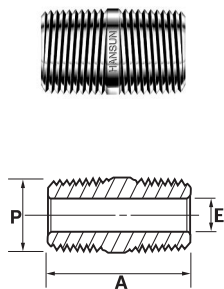

Код	P резьба NPT	A	E
P-SCN-2N	1/8	19.05	4.8
P-SCN-4N	1/4	28.4	7.1
P-SCN-6N	3/8	28.4	9.6
P-SCN-8N	1/2	31.7	11.9
P-SCN-12N	3/4	31.7	15.7
P-SCN-16N	1	47.8	22.4

P-SHN

Ниппель шестигранный с резьбой NPT

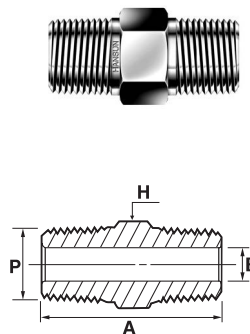

Код	P резьба NPT	A	E	H
P-SHN-2N	1/8	25.4	4.8	11.1
P-SHN-4N	1/4	35.3	7.1	14.2
P-SHN-6N	3/8	36.1	9.6	17.4
P-SHN-8N	1/2	46.7	11.9	22.2
P-SHN-12N	3/4	46.7	15.7	26.9
P-SHN-16N	1	58.7	22.3	34.9

P-SHRN

Ниппель шестигранный переходной с резьбой NPT

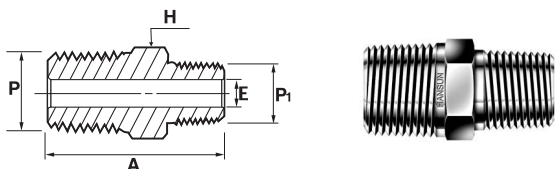

Код	P резьба NPT	P1 резьба NPT	A	E	H
P-SHRN-4-2N	1/4	1/8	30.7	4.8	14.2
P-SHRN-6-2N	3/8	1/8	32.0	4.8	17.4
P-SHRN-6-4N	3/8	1/4	36.1	7.1	17.4
P-SHRN-8-2N	1/2	1/8	37.2	4.8	22.2
P-SHRN-8-4N	1/2	1/4	41.7	7.1	22.2
P-SHRN-8-6N	1/2	3/8	41.7	9.6	22.2
P-SHRN-12-4N	3/4	1/4	41.7	7.1	26.9
P-SHRN-12-8N	3/4	1/2	46.7	11.9	26.9
P-SHRN-16-4N	1	1/4	49.3	7.1	34.9
P-SHRN-16-8N	1	1/2	54.1	11.9	34.9

P-SHN

Ниппель шестигранный с резьбой NPT / ISO (R)

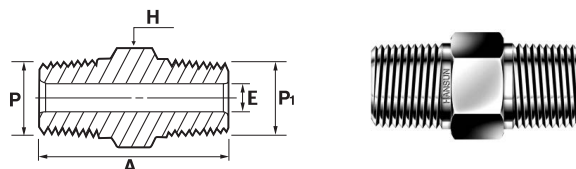

Код	P резьба NPT	P1 резьба BSP/ISO	A	E	H
P-SHN-2NR	1/8	1/8-28 7/1	24.6	4.1	11.1
P-SHN-4NR	1/4	1/4-19 7/1	35.6	6.4	14.2
P-SHN-6NR	3/8	3/8-19 7/1	36.3	9.7	17.4
P-SHN-8NR	1/2	1/2-14 7/1	46	11.9	22.2
P-SHN-12NR	3/4	3/4-14 7/1	46.7	15.7	26.9
P-SHN-16NR	1	1-11 7/1	28.9	22.4	34.9

P-SHN

Ниппель шестигранный с резьбой NPT / ISO (G)

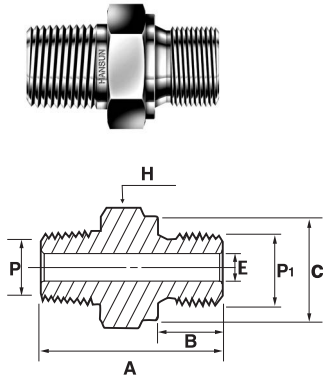

Код	Р резьба NPT	P1 резьба G/BSP/ISO	A	B	C	E	H
P-SHN-2NG	1/8	1/8-28 228/1	27.4	7.1	13.7	4.1	14.2
P-SHN-4NG	1/4	1/4-19 228/1	36.8	11.2	17.8	5.8	19.05
P-SHN-6NG	3/8	3/8-19 228/1	37.6	11.2	21.8	7.9	22.2
P-SHN-8NG	1/2	1/2-14 228/1	45.0	14.2	26.1	11.9	26.9
P-SHN-12NG	3/4	3/4-14 228/1	49.0	15.7	31.5	15.7	33.3
P-SHN-16NG	1	1-11 228/1	56.9	18.3	38.9	19.8	41

P-SHLN

Ниппель шестигранный удлиненный с резьбой NPT

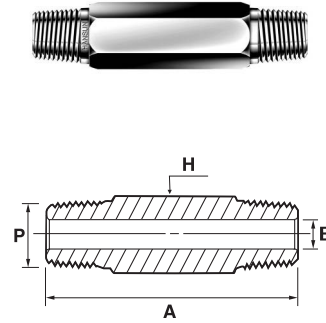

Код	Р резьба NPT	А в дюймах	E	H
P-SHLN-2N	1/8	*	4.8	11.1
P-SHLN-4N	1/4	*	7.1	14.2
P-SHLN-6N	3/8	*	9.7	17.4
P-SHLN-8N	1/2	*	11.9	22.2
P-SHLN-12N	3/4	*	15.7	26.9
P-SHLN-16N	1	*	22.4	34.9

P-MFAA

Адаптер с резьбой NPT

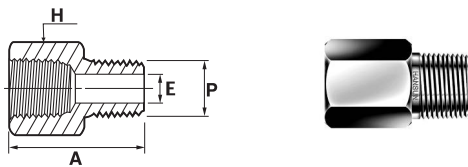

Код	Р резьба NPT	A	E	H
P-MFAA-2N	1/8	27.4	4.8	14.2
P-MFAA-4N	1/4	35.6	7.1	19.05
P-MFAA-6N	3/8	37.8	9.6	22.2
P-MFAA-8N	1/2	49.0	11.9	26.9
P-MFAA-12N	3/4	50.3	15.7	31.7
P-MFAA-16N	1	58.0	22.3	41.2

P-MFRA

Адаптер переходной с резьбой NPT

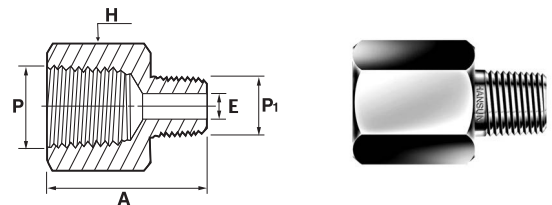

Код	Р резьба NPT	P1 резьба NPT	A	E	H
P-MFRA-2-4N	1/4	1/8	31.5	4.8	19.05
P-MFRA-2-6N	3/8	1/8	33.5	4.8	22.2
P-MFRA-4-6N	3/8	1/4	37.8	7.1	22.2
P-MFRA-2-8N	1/2	1/8	40.0	4.8	26.9
P-MFRA-4-8N	1/2	1/4	44.5	7.1	26.9
P-MFRA-6-8N	1/2	3/8	44.5	9.6	26.9
P-MFRA-4-12N	3/4	1/4	45.7	7.1	31.8
P-MFRA-6-12N	3/4	3/8	45.7	9.6	31.8
P-MFRA-8-12N	3/4	1/2	51.1	11.9	31.8
P-MFRA-4-16N	1	1/4	50.8	7.1	41.2
P-MFRA-8-16N	1	1/2	54.9	11.9	41.2
P-MFRA-12-16N	1	3/4	55.1	15.7	41.2

P-MFAA

Адаптер переходной с резьбой NPT / ISO (R)

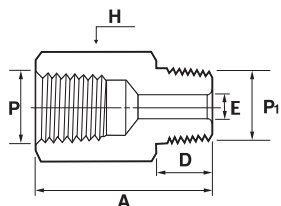

P-MFAB

Адаптер переходной с резьбой NPT / ISO (G)

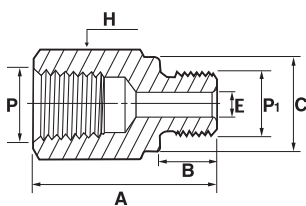

Код	P резьба	P1 BSP/ISO резьба	A	D	E	H
P-MFAA-2RN	1/8	1/8-28 7/1	27.4	9.7	4.8	14.2
P-MFAA-4RN	1/4	1/4-19 7/1	35.8	14.2	7.1	19.05
P-MFAA-6RN	3/8	3/8-19 7/1	37.6	14.2	9.7	22.2
P-MFAA-8RN	1/2	1/2-14 7/1	49.0	19.1	11.9	26.9
P-MFAA-12RN	3/4	3/4-14 7/1	50.3	19.1	15.7	31.8
P-MFAA-16RN	1	1-11 7/1	58.0	23.9	22.3	41.2

Код	P NPT	P1 BSP/ISO резьба	A	B	C	E	H
P-MFAB-2GN	1/8	1/8-28 228/1	24.9	7.1	13.7	4.1	14.2
P-MFAN-4GN	1/4	1/4-19 228/1	33.3	11.2	17.8	5.8	19.05
P-MFAB-6GN	3/8	3/8-19 228/1	37.8	11.2	21.8	7.9	22.2
P-MFAB-8GN	1/2	1/2-14 228/1	43.9	14.2	26.1	11.9	26.9
P-MFAB-12GN	3/4	3/4-14 228/1	50.8	15.7	31.5	15.7	33.3
P-MFAB-16GN	1	1-11 228/1	53.1	18.3	38.9	19.8	41.2

P-SHB

Футорка с резьбой NPT

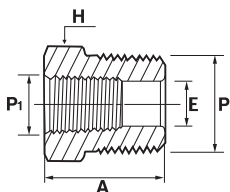

Код	P резьба NPT	P1 резьба NPT	A	E	H	316SS	Латунь	Углеродистая сталь
P-SHB-4-2N	1/4	1/8	26.7	7.1	14.2	5600	3100	6200
P-SHB-6-2N	3/8	1/8	21.8	8.5	17.4			
P-SHB-6-4N	3/8	1/4	30.0	9.6	19.05	5200	3100	6200
P-SHB-8-2N	1/2	1/8	27.4	8.5	22.2	-	-	-
P-SHB-8-4N	1/2	1/4	27.4	11.7	22.2	5800	3100	6200
P-SHB-8-6N	1/2	3/8	35.6	11.9	22.2	4400	2500	5100
P-SHB-12-4N	3/4	1/4	27.4	11.4	26.9	-	-	-
P-SHB-12-6N	3/4	3/8	27.4	15.0	26.9	-	-	-
P-SHB-12-8N	3/4	1/2	41.4	15.7	26.9	-	-	-
P-SHB-16-4N	1	1/4	34.8	11.4	34.9	-	-	-
P-SHB-16-8N	1	1/2	34.8	18.5	34.9	-	-	-
P-SHB-16-12N	1	3/4	34.8	22.4	34.9	--	-	-

P-SC

Заглушка с резьбой NPT

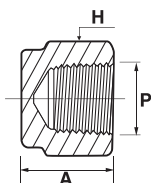

Код	Р резьба NPT	A	H
P-SC-2N	1/8	19.1	14.2
P-SC-4N	1/4	22.9	19.05
P-SC-6N	3/8	26.2	22.2
P-SC-8N	1/2	34.0	26.9
P-SC-12N	3/4	36.6	31.8
P-SC-16N	1	41.1	41.2

P-SP

Пробка с резьбой NPT



Код	Р резьба NPT	A	H
P-SP-2N	1/8	19.05	11.1
P-SP-4N	1/4	24.1	14.2
P-SP-6N	3/8	25	17.4
P-SP-8N	1/2	30.5	22.2
P-SP-12N	3/4	30.5	26.9
P-SP-16N	1	38.1	34.9

P-SHC

Муфта с резьбой NPT

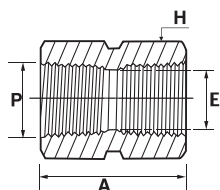

Код	Р резьба NPT	A	E	H
P-SHC-2N	1/8	20.3	8.9	14.2
P-SHC-4N	1/4	30.0	11.7	19.5
P-SHC-6N	3/8	33.0	15.0	22.2
P-SHC-8N	1/2	39.4	18.7	26.9
P-SHC-12N	3/4	41.0	23.5	31.8
P-SHC-16N	1	50.5	29.7	41.2

P-SHRC

Муфта переходная с резьбой NPT

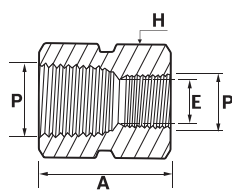

Код	Р резьба NPT	P1 резьба NPT	A	E	H
P-SHRC-4-2N	1/4	1/8	31.2	8.9	19.05
P-SHRC-6-4N	3/8	1/4	34.8	11.7	22.2
P-SHRC-8-2N	1/2	1/8	39.4	8.7	26.9
P-SHRC-8-4N	1/2	1/4	44.2	11.7	26.9
P-SHRC-8-6N	1/2	3/8	45.0	15.0	26.9
P-SHRC-12-4N	3/4	1/4	45.7	11.7	31.8
P-SHRC-12-8N	3/4	1/2	52.0	18.7	31.8
P-SHRC-16-4N	1	1/4	50.8	11.7	41.2
P-SHRC-16-8N	1	1/2	55.4	18.7	41.2
P-SHRC-16-12N	1	3/4	57.0	23.5	41.2

P-SL

Угольник резьбой NPT

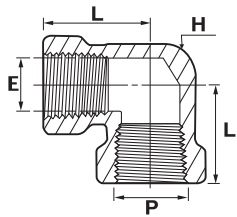

P-SSL

Угольник с резьбой NPT

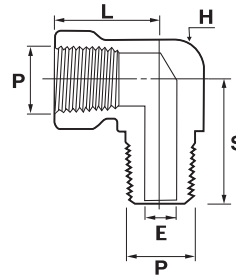

Код	Р резьба NPT	L	E	H
P-SL-2N	1/8	24.1	8.9	12.7
P-SL-4N	1/4	29.0	11.7	17.5
P-SL-6N	3/8	34.5	15.0	20.6
P-SL-8N	1/2	37.0	18.7	25.4
P-SL-12N	3/4	46.5	23.5	31.8
P-SL-16N	1	48.8	29.7	42.9

Код	Р резьба NPT	L	S	E	H
P-SSL-2N	1/8	24.1	19.6	4.8	12.7
P-SSL-4N	1/4	29.0	26.5	7.1	17.5
P-SSL-6N	3/8	34.5	28.2	9.6	20.6
P-SSL-8N	1/2	37.0	35.3	11.9	25.4
P-SSL-12N	3/4	46.5	39.6	15.7	31.8
P-SSL-16N	1	48.8	49.2	22.3	42.9

P-SRSL

Угольник переходной с резьбой NPT

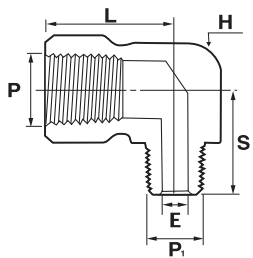

P-SML

Угольник с резьбой NPT

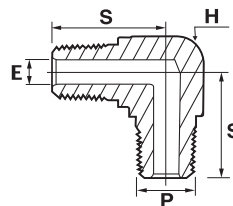

Код	Р резьба NPT	Р резьба NPT	L	S	E	H
P-SRSL-4-2N	1/4	1/8	29.0	22.4	4.8	17.5
P-SRSL-6-4N	3/8	1/4	34.5	28.2	7.1	20.6
P-SRSL-8-4N	1/2	1/4	37.0	30.5	7.1	25.4
P-SRSL-8-6N	1/2	3/8	37.0	30.5	9.6	25.4
P-SRSL-12-8N	3/4	1/2	46.5	39.6	11.9	31.8
P-SRSL-16-8N	1	1/2	48.8	44.5	11.9	42.9

Код	Р резьба NPT	S	E	H
P-SML-2N	1/8	19.05	4.8	12.7
P-SML-4N	1/4	24.5	7.1	12.7
P-SML-6N	3/8	26.9	9.6	17.5
P-SML-8N	1/2	33.2	11.9	20.6
P-SML-12N	3/4	35.3	15.7	25.4
P-SML-16N	1	44.5	22.3	31.8

P-ST

Тройник с резьбой NPT

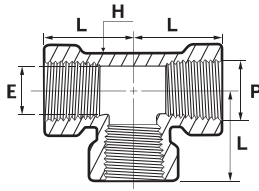

Код	Р резьба NPT	L	E	H
P-ST-2N	1/8	24.1	8.9	12.7
P-ST-4N	1/4	29.0	11.7	17.5
P-ST-6N	3/8	34.5	15.0	20.6
P-ST-8N	1/2	37.0	18.7	25.4
P-ST-12N	3/4	46.5	23.5	31.8
P-ST-16N	1	48.5	29.7	42.8

P-SRT

Тройник с резьбой NPT

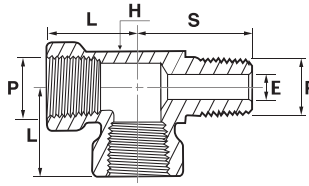

Код	Р резьба NPT	L	S	E	H
P-SRT-2N	1/8	24.1	19.6	4.8	12.7
P-SRT-4N	1/4	29.0	26.5	7.1	17.5
P-SRT-6N	3/8	34.5	28.2	9.6	20.6
P-SRT-8N	1/2	37.0	35.3	11.9	25.4
P-SRT-12N	3/4	46.5	39.6	15.7	31.8
P-SRT-16N	1	48.8	49.2	22.3	42.9

P-SBT

Тройник с резьбой NPT

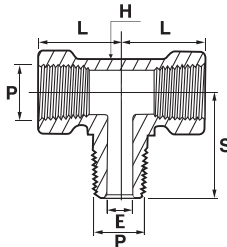

Код	Р резьба NPT	L	S	E	H
P-SBT-2N	1/8	24.1	19.6	4.8	12.7
P-SBT-4N	1/4	29.0	26.5	7.1	17.5
P-SBT-6N	3/8	34.5	28.2	9.6	20.6
P-SBT-8N	1/2	37.0	35.3	11.9	25.4
P-SBT-12N	3/4	46.5	39.6	15.7	31.8
P-SBT-16N	1	48.8	49.2	22.3	42.9

P-SMT

Тройник с резьбой NPT

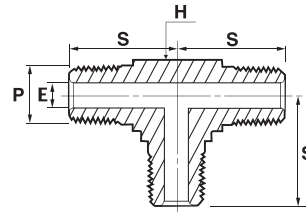

Код	Р резьба NPT	S	E	H
P-SMT-2N	1/8	19.05	4.8	12.7
P-SMT-4N	1/4	24.5	7.1	12.7
P-SMT-6N	3/8	26.9	9.6	17.5
P-SMT-8N	1/2	33.2	11.9	20.6
P-SMT-12N	3/4	35.3	15.7	25.4
P-SMT-16N	1	44.5	22.3	31.8

P-SUJ

Муфта разборная с резьбой NPT

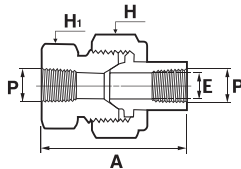

Код	Р резьба NPT	A	E	H	H1
P-SUJ-F-2N	1/8	45.7	6.9	28.6	23.8
P-SUJ-F-4N	1/4	59.4	9.1	34.9	30.2
P-SUJ-F-6N	3/8	63.5	13.2	38.1	33.3
P-SUJ-F-8N	1/2	68.6	15.7	44.5	41.3
P-SUJ-F-12N	3/4	79.2	22.4	50.8	47.6
P-SUJ-F-16N	1	90.4	26.2	63.5	60.3

SGC

Кольцо уплотнительное для резьбы ISO (G)

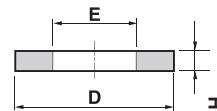

Код	Р резьба NPT	E	H	D
SGC-2N	1/8	10.0	2.0	18.0
SGC-4N	1/4	14.0	2.0	22.0
SGC-6N	3/8	17.0	2.0	26.0
SGC-8N	1/2	22.0	2.0	32.0
SGC-12N	3/4	27.0	2.0	38.0
SGC-16N	1	34.0	2.0	42.0

P-SWFC

Муфта под приварку

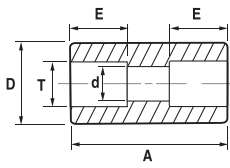

Код	T	d	D	E	A		
P-SWFC-4T	1/4	4.6	13.0	7.1	19.0	10,000	689
P-SWFC-6T	3/8	7.1	15.8	7.9	22.4	7,600	523
P-SWFC-8T	1/2	10.2	19.0	9.7	26.9	6,200	427
P-SWFC-10T	5/8	12.7	24.0	10.4	30.2	6,400	440
P-SWFC-12T	3/4	15.7	26.9	11.2	33.3	5,500	378
P-SWFC-16T	1	22.1	35.0	15.7	36.6	5,200	358

P-SWLA

Угольник под приварку

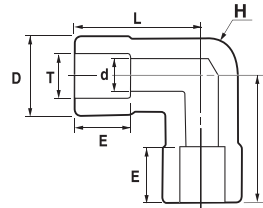

Код	T	d	D	E	H	L		
P-SWLA-4T	1/4	4.6	13.4	7.1	12.7	21.8	11,300	778
P-SWLA-6T	3/8	7.1	15.8	7.9	12.7	24.5	8,400	578
P-SWLA-8T	1/2	10.2	20.6	9.7	17.4	29.0	7,800	537
P-SWLA-10T	5/8	12.7	23.8	10.4	20.6	34.5	6,700	461
P-SWLA-12T	3/4	15.7	28.6	11.2	25.4	37.0	6,700	461
P-SWLA-16T	1	22.1	35.0	15.7	31.8	46.5	6,100	420

P-SWTA

Тройник под приварку

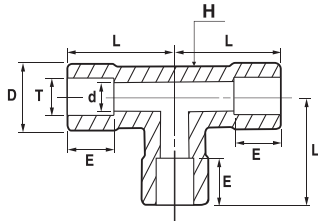

Код	P	d	D	E	H	L		
P-SWTA-2T	1/8	2.3	13.4	2.5	12.7	15.0	11,800	813
P-SWTA-4T	1/4	4.6	13.4	7.1	12.7	21.8	11,300	778
P-SWTA-6T	3/8	7.1	15.8	7.9	12.7	24.5	8,400	578
P-SWTA-8T	1/2	10.2	20.6	9.7	17.4	29.0	7,800	537
P-SWTA-10T	5/8	12.7	23.8	10.4	20.6	34.5	6,700	461
P-SWTA-12T	3/4	15.7	28.6	11.2	25.4	37.0	6,700	461
P-SWTA-16T	1	22.1	35.0	15.7	31.8	46.5	6,100	420

P-SSA

Штуцер под приварку с резьбой NPT

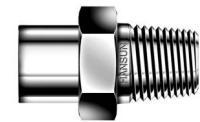
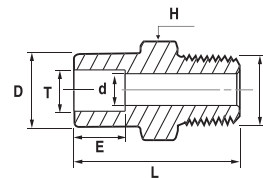

Код	T	P NPT	d	D	E	H	L		
P-SSA-4T-2N	1/4	1/8	4.6	12.2	7.1	14.2	29.2	7,500	516
P-SSA-6T-4N	3/8	1/4	7.1	15.3	7.9	15.8	31.8	7,500	516
P-SSA-6T-6N	3/8	3/8	7.1	15.3	7.9	17.4	31.8	7,300	502
P-SSA-6T-8N	3/8	1/2	7.1	15.3	7.9	22.2	37.3	7,200	496
P-SSA-8T-4N	1/2	1/4	7.1	18.5	9.7	19.05	33.3	6,200	427
P-SSA-8T-6N	1/2	3/8	9.4	18.5	9.7	19.05	33.3	6,200	427
P-SAA-8T-8N	1/2	1/2	10.2	18.5	9.7	22.2	38.9	6,200	427

P-SSB

Штуцер под приварку с резьбой NPT

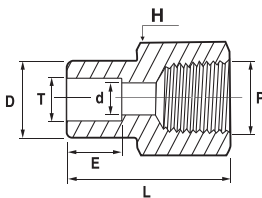

Код	T	P NPT	d	D	E	H	L		
P-SSB-2T-2N	1/8	1/8	2.3	7.4	2.5	14.2	21.1	6,100	420
P-SSB-4T-2N	1/4	1/8	4.6	12.2	7.1	14.2	26.7	6,100	420
P-SSB-4T-4N	1/4	1/4	4.6	12.2	7.1	19.05	30.0	6,200	427
P-SSB-6T-4N	3/8	1/4	7.1	15.3	7.9	19.05	31.5	6,200	427
P-SSB-8T-6N	1/2	3/8	10.2	18.5	9.7	22.2	34.5	5,000	344
P-SSB-8T-8N	1/2	1/2	10.2	18.5	9.7	26.9	40.4	4,600	316
P-SSB-10T-8N	5/8	1/2	12.7	23.4	10.4	24.9	41.9	4,600	316
P-SSB-12T-12N	3/4	3/4	15.7	26.7	11.2	33.3	43.9	4,300	296

P-SMLSW

Угольник под приварку с резьбой NPT

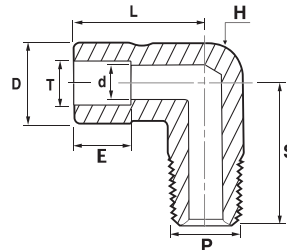

Код	T	P NPT	d	D	E	H	L	S	
P-SMLSW-4T-4N	1/4	1/4	4.6	15.8	7.1	12.7	20.1	24.5	7,500
P-SMLSW-6T-4N	3/8	1/4	7.1	15.8	7.9	12.7	24.1	24.5	7,500
P-SMLSW-6T-6N	3/8	3/8	7.1	20.6	7.9	17.4	24.6	29.0	7,300
P-SMLSW-6T-8N	3/8	1/2	7.1	23.8	7.9	20.6	25.9	34.5	7,200
P-SMLSW-8T-8N	1/2	1/2	10.2	23.8	9.7	20.6	27.4	34.5	6,200
P-SMLSW-12T-12N	3/4	3/4	15.7	28.6	11.2	25.4	37.0	37.0	6,700

P-SFLSW

Угольник под приварку с резьбой NPT

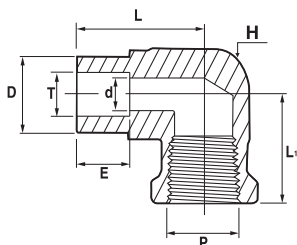

P-SWRM

Муфта под приварку

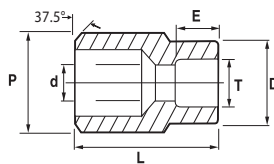

Код	T	P NPT	d	D	E	H	L	L1		
P-SFLSW-4T-4N	1/4	1/4	4.6	12.2	7.1	17.4	22.9	29.7	6,200	427
P-SFLSW-6T-4N	3/8	1/4	7.1	15.3	7.9	17.4	25.1	29.7	7,000	482
P-SFLSW-6T-8N	3/8	1/2	7.1	15.3	7.9	25.4	28.7	37.0	5,400	372
P-SFLSW-8T-8N	1/2	1/2	10.2	18.5	9.7	25.4	30.2	37.0	5,400	372

Код	P	T	d	D	E	L		
P-SWRM-4P-4T	1/4	1/4	4.6	13.7	7.1	22.4	9,600	661
P-SWRM-6P-6T	3/8	3/8	7.1	15.3	7.9	26.2	7,600	523
P-SWRM-6P-8T	3/8	1/2	10.2	18.5	9.7	27.9	6,200	427
P-SWRM-8P-4T	1/2	1/4	4.6	12.2	7.1	28.4	7,300	502
P-SWRM-8P-6T	1/2	3/8	7.1	15.3	7.9	28.4	7,300	502
P-SWRM-8P-8T	1/2	1/2	10.2	18.5	9.7	30.2	6,200	427
P-SWRM-12P-6T	3/4	3/8	7.1	15.3	7.9	38.1	6,200	427
P-SWRM-12P-8T	3/4	1/2	10.2	18.5	9.1	38.1	6,200	427

P-SWRM

Муфта под приварку

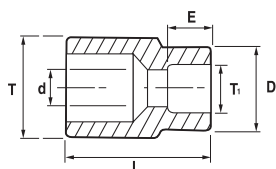

Код	T	T1	d	D	E	L		
P-SWRM-4T-2T	1/4	1/8	2.3	7.4	2.5	14.2	11,800	813
P-SWRM-6T-4T	3/8	1/4	4.6	12.2	7.1	19.1	7,700	530
P-SWRM-8T-4T	1/2	1/4	4.6	18.2	7.1	22.4	7,000	482
P-SWRM-8T-6T	1/2	3/8	8.1	15.7	7.9	22.4	7,000	482
P-SWRM-12T-8T	3/4	1/2	10.2	18.5	9.7	28.4	5,900	406
P-SWRM-16T-8T	1	1/2	10.2	18.5	9.7	35.1-	5,600-	344-



- | | | | |
|------------------------------------|--|---------------------------------------|----------------------------------|
| Архангельск (8182)63-90-72 | Калининград (4012)72-03-81 | Новосибирск (383)227-86-73 | Сочи (862)225-72-31 |
| Астана +7(7172)727-132 | Калуга (4842)92-23-67 | Омск (3812)21-46-40 | Ставрополь (8652)20-65-13 |
| Астрахань (8512)99-46-04 | Кемерово (3842)65-04-62 | Орел (4862)44-53-42 | Сургут (3462)77-98-35 |
| Барнаул (3852)73-04-60 | Киров (8332)68-02-04 | Оренбург (3532)37-68-04 | Тверь (4822)63-31-35 |
| Белгород (4722)40-23-64 | Краснодар (861)203-40-90 | Пенза (8412)22-31-16 | Томск (3822)98-41-53 |
| Брянск (4832)59-03-52 | Красноярск (391)204-63-61 | Пермь (342)205-81-47 | Тула (4872)74-02-29 |
| Владивосток (423)249-28-31 | Курск (4712)77-13-04 | Ростов-на-Дону (863)308-18-15 | Тюмень (3452)66-21-18 |
| Волгоград (844)278-03-48 | Липецк (4742)52-20-81 | Рязань (4912)46-61-64 | Ульяновск (8422)24-23-59 |
| Вологда (8172)26-41-59 | Магнитогорск (3519)55-03-13 | Самара (846)206-03-16 | Уфа (347)22948 -12 |
| Воронеж (473)204-51-73 | Москва (495)268-04-70 | Санкт-Петербург (812)309-46-40 | Хабаровск (4212)92-98-04 |
| Екатеринбург (343)384-55-89 | Мурманск (8152)59-64-93 | Саратов (845)249-38-78 | Челябинск (351)202-03-61 |
| Иваново (4932)77-34-06 | Набережные Челны (8552)20-53-41 | Севастополь (8692)22-31-93 | Череповец (8202)49-02-64 |
| Ижевск (3412)26-03-58 | Нижний Новгород (831)429-08-12 | Симферополь (3652)67-13-56 | Ярославль (4852)69-52-93 |
| Казань (843)206-01-48 | Новокузнецк (3843)20-46-81 | Смоленск (4812)29-41-54 | |

Единый адрес для всех регионов: skb@nt-rt.ru || www.s-lok.nt-rt.ru